



Heckmann Building Products Inc.

1501 N. 31st Avenue
Melrose Park, IL 60160-2911
800-621-4140 or 708-865-2403
Fax: 708-865-2640

Date _____

WebSite: www.heckmannanchors.com
E-Mail: info@heckmannanchors.com

To: Heckmann Sales Department

From:

#117 Dovetail Stone Anchor

Quantity _____

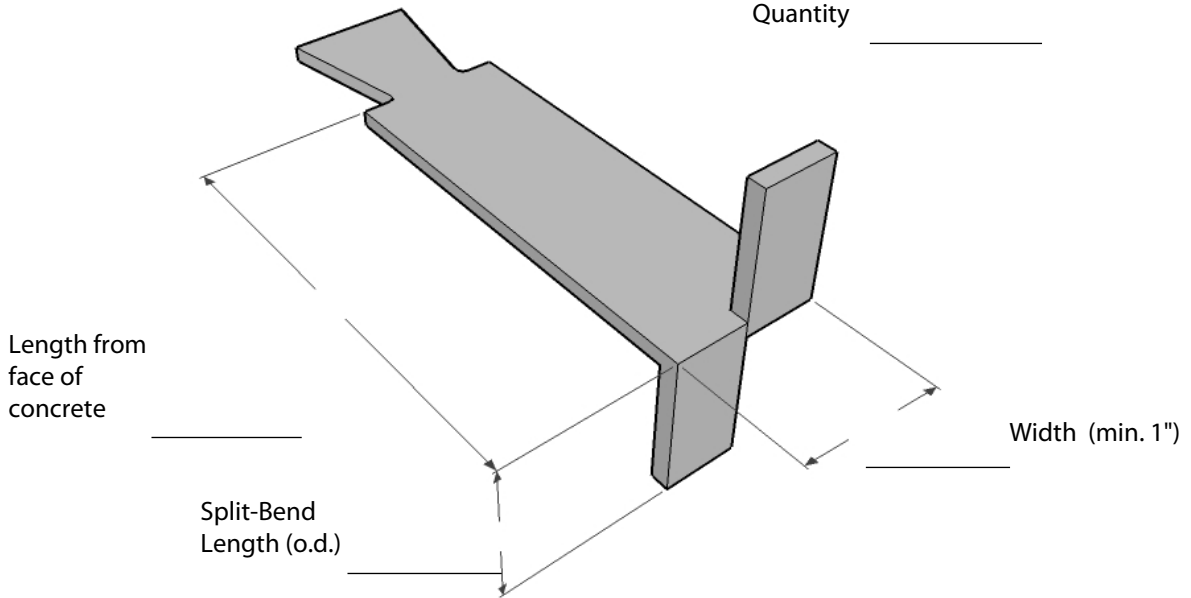

Material Thickness (click on one)

Steel Type (click on one)

Notes